

Reduction of proximal metal structures interference for a Holographic RADAR 3D-Printed antenna

1st Luca Bossi

Department of Information Engineering
Università degli Studi di Firenze
Florence, Italy
l.bossi@unifi.it

2nd Pierluigi Falorni

Department of Information Engineering
Università degli Studi di Firenze
Florence, Italy
pfalorni@gmail.com

3rd Lorenzo Capineri

Department of Information Engineering
Università degli Studi di Firenze
Florence, Italy
lorenzo.capineri@unifi.it

4th Gennadiy Pochanin

Department of Radiophysical
Introscopy
O.Ya.Usikov Institute for Radiophysics
and Electronics of NAS of Ukraine
Kharkiv, Ukraine
gp.pochanin@gmail.com

5th Fronfield Crawford

Department of Physics and Astronomy
Franklin and Marshall College
Lancaster, PA, USA
ORCID: 0000-0002-2578-0360

Abstract— Holographic RADAR images are used for investigating dielectric discontinuities in the soil. We use a holographic RADAR for landmine classification in humanitarian demining efforts. To improve the performance of the holographic RADAR, we developed an innovative 3D-Printed plastic waveguide antenna. The back-lobe radiation of this antenna interacts with the metallic mechanical scanning system generating artefacts in the images. To reduce the interaction effects, we built a Faraday cage for the antenna. To validate the performance of this shielded antenna we built a laboratory test bed in which electromagnetically similar objects to landmines could be placed in a controlled environment to inspect and visualize the shield's effects. For this experiment we have used a box filled with water. The results show that the Faraday cage has a significant impact on the attenuation of interference in the images. These encouraging results indicate that our antenna design can be improved by reducing the radiation back lobe effect.

Keywords—Holographic RADAR, GPR, HSR, Penetrating RADAR, Microwaves, 3D Printing, Antenna, Testbed, Landmines, Demining

I. INTRODUCTION

The holographic Subsurface RADAR has been applied to humanitarian demining for classification of landmines buried in the subsoil (typically up to a depth of 15 cm) [1], [2]. The holographic microwave imaging system requires mechanical motion to cover the surface terrain under investigation. Recently we developed an innovative holographic RADAR waveguide antenna fabricated completely with three-dimensional printing technology [3]. The small size of the antenna permits us to extend the surface of investigation by using mechanical movement of the frame onboard the robotic platform “Ugo 1st” [1], where the antenna is installed. Generally, the back and side lobes radiation of the antenna interacts with the mechanical scanning frame, and this affects the microwave images acquired (an example is shown in Figure 1). This reduces the contrast of the target on the image. The acquisitions made with the new antenna are even more significantly affected by this undesirable effect. To improve the sensitivity of the microwave imaging system we have designed and validated, we have investigated the effects of a shielding cage added to the antenna.

For the evaluation of the effects of the cage on the images, experimentation using a landmine test field is not useful owing characteristics of the terrain. Specifically, the terrain is a non-homogeneous medium electromagnetically, and the

dispersion is strongly influenced by the water content, which should be measured before each test. Searching in the literature [4] for how to avoid this problem and how to obtain a homogeneous medium with a well-defined dielectric permittivity yielded an innovative approach to the microwave imaging system validation. For the microwave bandwidth of our interest (1.5 to 2 GHz), we designed and characterized a plastic box with dimensions 39 cm, 57 cm, 28 cm (l, d, h) and filled it with water (details are presented in another abstract in this conference). In this manner, laboratory experiments on reference targets could be performed with a guarantee of repeatability of the measurements.

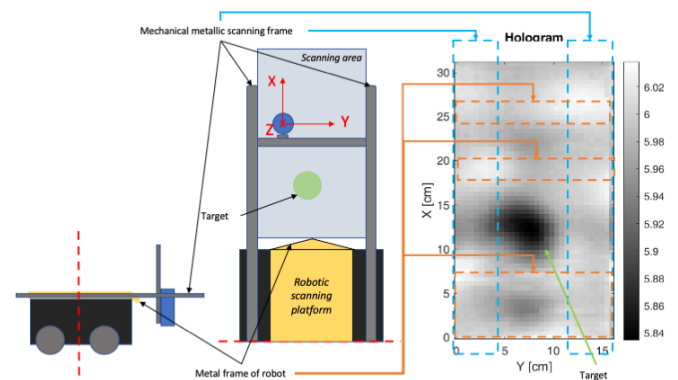

Figure 1 - Schematic representation of the robotic scanning system (on the left and in the center); Example image of a plastic target with diameter 7.5 cm is shown (right). The effects of the electromagnetic interactions between the antenna and the metallic frame are visible around the scanned area.

II. METHODS

A. Three-dimensional printed antenna

As part of NATO SPS project G5731, we designed and fabricated a waveguide antenna for holographic RADAR specifically for use in landmine fields. The antenna was designed for the installation on the robotic platform named “Ugo 1st”. We have developed a sensor which has been

completely built with 3D printing technology (Figure 2). Filling the waveguide of the antenna with PLA (Polylactic Acid) permitted us to decrease antenna dimensions by square root from permittivity of PLA times and obtain an antenna smaller than the commonly used air filled waveguide antenna for landmine classification. At working frequency 2 GHz (the wavelength is of 150 mm) it requires an antenna of diameter of about 110 mm. The antenna fabricated from plastic has a diameter of 62 mm.

The table in Figure 2 reports the dimensions of the antenna. Once the antenna was designed, the performance was optimized with the simulation software Dassault Systèmes CST Microwave Studio®.

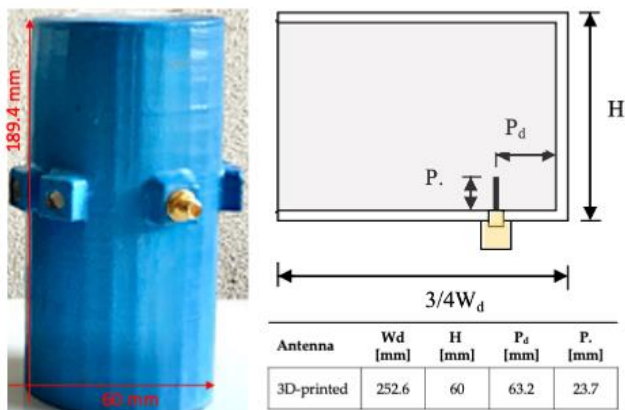

Figure 2 - Three-dimensional printed antenna (on the left) and the design draw and sizes (on the right).

The fabrication steps are illustrated in Figure 3 with a description of each step.

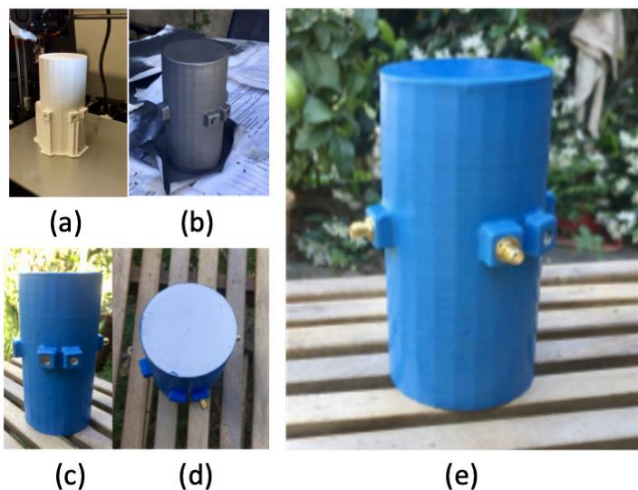

Figure 3 - Fabrication of the plastic antenna. From (a) to (e): (a) printing, (b) shielding with conductive nickel-based paint, (c and d) coating with protective acrylic paint, and (e) the finished antenna with feeds mounted.

B. Shielding cage

Despite of shielding of antenna with conductive paint there is notable electromagnetic field in the near zone of the antenna. At scanning the field reflects from metallic parts of scanner and comes to the radar receiver. This signal is clutter for the radar measurements. The problem is mostly

unpredictable changing amplitude of clutter signal at scanning. To decrease influence of clutter we fabricated a cage represented in Figure 4. It intended to make lower and more stabilized clutter level independently from the antenna position inside the scanner.

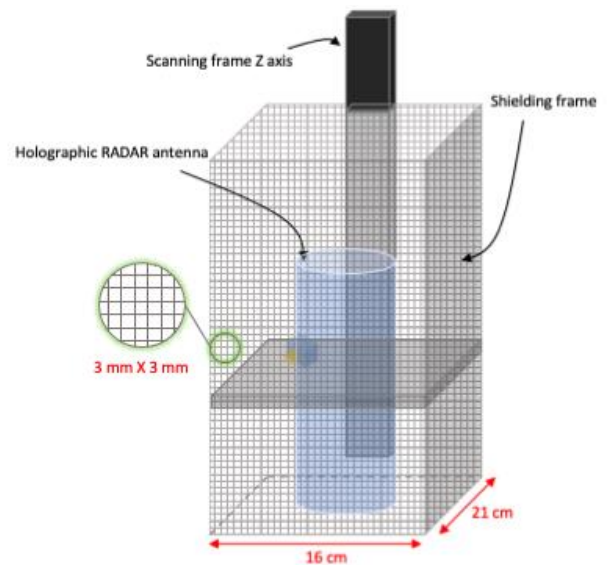

Figure 4 - Antenna head with cage. The size and pattern of the cage are indicated in the diagram.

The cage is modelled starting from a folded metal mesh made of galvanized iron. The dimensions of the grid are about 1/50 of the wavelength, and the thickness is about 1 mm. The bottom of the shielding mesh is at the same level as the antenna aperture. The top is higher than the antenna since it contains the driving electronics of the RADAR.

The cage was electrically connected to the ground of the system.

C. Mechanical scanning frame

The metallic mechanical scanning frame is the three-axis positioning system EXCM-30 produced and specially designed by Festo® for devices that require highly accurate positioning precision. To the basic X-Y frame we added the Z axis to vary the antenna height over the soil. The mechanical system is driven by the PLC controller CECC-X-M1, programmed by a custom software. Thus, the system can execute same scanning paths at different antenna heights.

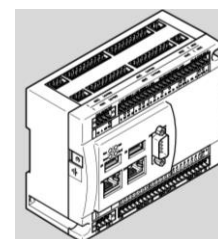

Figure 5 - PLC controller for mechanical acquisition system

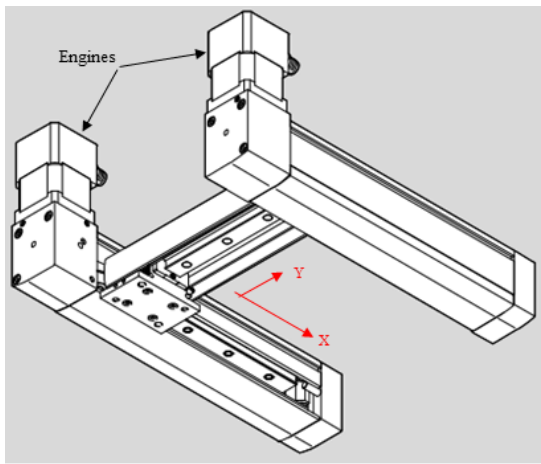

Figure 6 - Mechanical scanning frame representation (Z axis is not mounted). The frame dimensions are 44 cm X 41 cm.

D. Water-filled testbed

To validate the performance of the shielded antenna we built a laboratory testbed and prepared objects that were electromagnetically similar to landmines. Our testbed provided a controlled environment to visualize the shield's effects on the images. The testbed was built starting from a plastic box (Figure 7) with dimensions that were a little larger than the acquisition area. The plastic box was filled with pure water. The significant difference between the dielectric permittivity of the distilled water compared to the sample targets produced a large dielectric contrast, larger reflected signal and, as result, contrast images of the object. Moreover, the high dielectric permittivity of the distilled water and flat surface prevent undesirable diffraction phenomena, which, simulating well the effects of the air-soil interface in a real minefield.

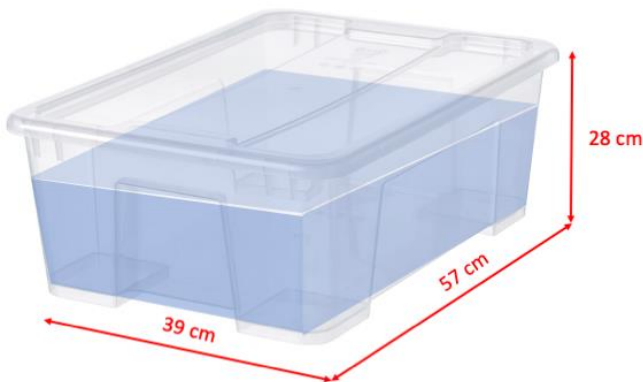

Figure 7 - Testbed filled with distilled water for laboratory experiments to validate the antenna Faraday cage shield effects. The dimensions of the plastic container are indicated in the figure.

III. EXPERIMENTS

The experiments were conducted in the laboratory. Figure 8 shows the setup of the experiments. The container filled with distilled water was positioned on a thin polystyrene foil (2 cm thick).

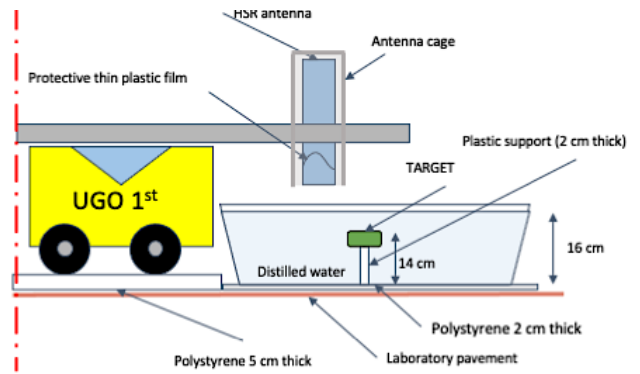

Figure 8 - Laboratory setup of the experiments consists of the testbed filled with distilled water on the right and the robotic platform "Ugo 1st" with scanning frame and holographic antenna mounted on the left.

The reference target was mounted on a plexiglass staff positioned under the target which was then anchored on the bottom of the testbed. We conducted three acquisitions with the holographic antenna without the cage and three with the cage. Figure 9 shows the reference target, a plastic candy box of 7.5 cm diameter and 3 cm height. The plastic box was filled with an epoxy resin. The acquisition was done on a grid with steps of 5 mm on a surface of 320 mm X 175 mm.

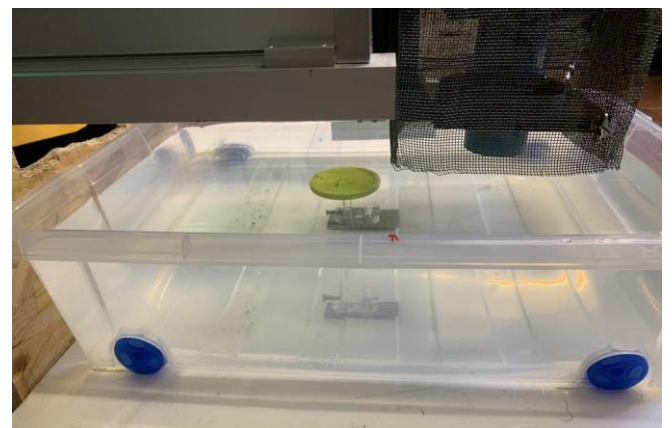
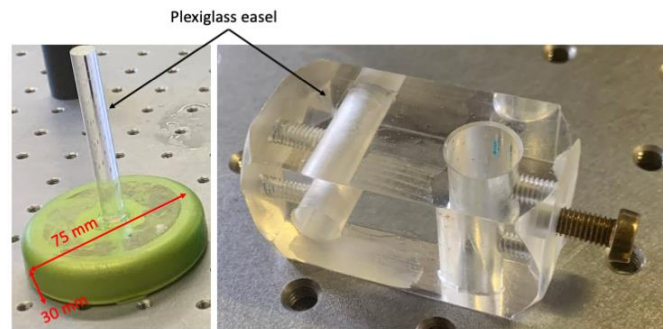

Figure 9 – Above: plastic resin filled target with size indicated and easel staff mounted (on the left); Easel base in plexiglass (on the right). Bottom: picture of system before acquisition was started.

Figure 10 shows the hologram amplitude acquired without the cage at a frequency of 1.66 GHz that is the best matching frequency in the working band of the antenna. The reflections of the metallic parts around the scanning area are highlighted in the image. Figure 11 shows the hologram amplitude acquired with the same acquisition settings as in Figure 10 but with the antenna cage mounted. The effects of

the metallic frame reflections are smoothed or not present here.

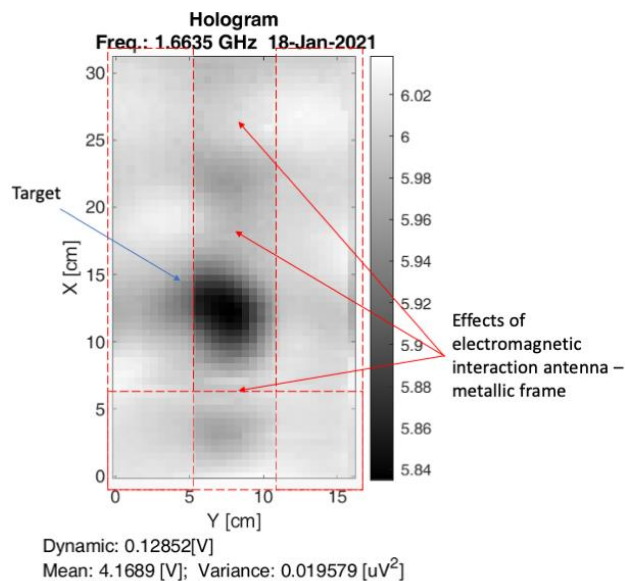

Figure 10 - Hologram amplitude of reference target placed within the distilled water. The RADAR antenna does not have the Faraday cage. The red dashed boxes show the effects of the electromagnetic interaction with the metallic frame around the scanning area.

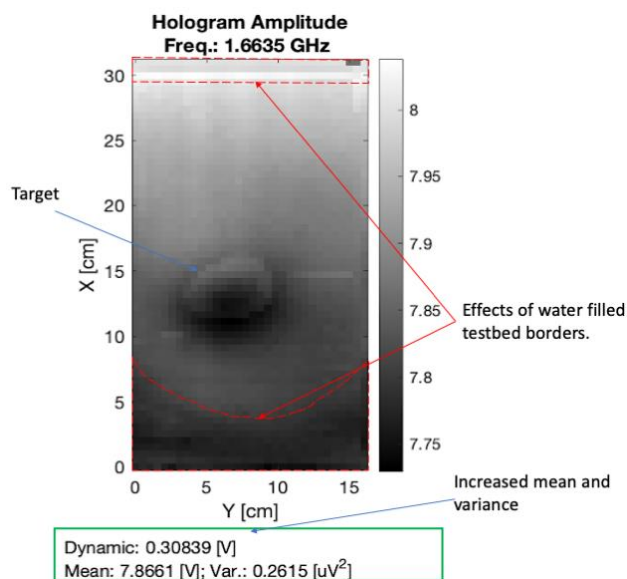

Figure 11 - Hologram amplitude of the same target in the same experimental setup as shown in Figure 10. Here the holographic RADAR antenna was shielded with the cage. Only the effect of the border of the testbed presents. The overall contrast of the image has also increased.

IV. CONCLUSIONS

We have presented the experimental setup and results of laboratory tests on an innovative plastic filled waveguide antenna shielded with a Faraday cage. The new antenna has an increased sensitivity and allows to reduce the undesired effects of the electromagnetic interaction of the side and back lobes of antenna radiation with the mechanical metallic frame around the scanning area. The acquisitions used in our tests were conducted on a reference plastic target that simulated a plastic landmine. For the experiments we fabricated a test bed filled with distilled water to ensure the repeatability of the measurements and to reduce the uncertainty of mine identification in a real minefield. We produced images of the same target with the same conditions and position but in two cases: with and without the faraday cage on the antenna. In the image acquired without the antenna cage in Figure 10, the effects of electromagnetic interactions with the metallic frame around the scanning area are well observable. The reflections from metallic parts reduce noticeably the signal to clutter ratio of the image. This aspect is clear from the Figure 11 where the image acquired with the antenna with the Faraday cage mounted. It improved dynamic range of registered signals. This encouraging result suggests the use allows use of a new, filled antenna with a 3D printed external Faraday cage integrated into the system.

ACKNOWLEDGMENT

The work presented in this abstract was funded in part by the NATO SPS project G5731.

REFERENCES

- [1] "Holographic and Impulse Subsurface Radar for Landmine and IED Detection." <http://www.nato-sfps-landmines.eu/> (accessed Sep. 17, 2020).
- [2] L. Bossi *et al.*, "Design of a robotic platform for landmine detection based on Industry 4.0 paradigm with data sensors integration," in *IEEE Xplore*, 2020, pp. 16–20. doi: 10.1109/MetroInd4.0IoT48571.2020.9138227.
- [3] L. Bossi, P. Falorni, S. Priori, R. Olmi, and L. Capineri, "Numerical Design and Experimental Validation of a Plastic 3D-Printed Waveguide Antenna for Shallow Object Microwave Imaging," *Sens Imaging*, vol. 22, no. 1, p. 22, Dec. 2021, doi: 10.1007/s11220-021-00344-4.
- [4] M. Pieraccini, A. Bicci, D. Mecatti, G. Macaluso, and C. Atzeni, "Propagation of Large Bandwidth Microwave Signals in Water," *IEEE Trans. Antennas Propagat.*, vol. 57, no. 11, pp. 3612–3618, Nov. 2009, doi: 10.1109/TAP.2009.2025674.